

#### Main applications

- Plastics extrusion lines and injection moulding machines
- Packing and packaging machines
- Polymerization plant for synthetic fibre production
- Rubber moulding machinery
- Driers for ceramics and components for the building industries
- Chemical and pharmaceutical industries
- Industrial electric furnaces
- Food processing plants



#### Main features

- Alternating current solid state relay
- Zero crossing switching
- Control input from VDC/VAC logic signal
- Copper/semiconductor coupling technology
- 10, 15, 20, 25, 40, 50, 60, 90, and 120 Arms nominal current
- Non-repetitive voltage: up to 1200Vp
- Nominal Voltage: up to 600Vac
- Integrated SCR thermal protection with LED signal (only for models with > 40A current)
- 4000 Vrms optoinsulation (input-output)
- LED, drive input signal indicator
- MOV (varistors)

#### PROFILE

Zero crossing relay with antiparallel thyristor output is the most used solid state relay in industrial applications.

“Zero crossing” relay is energised when voltage meets the zero point and disenergised when current meets the zero point, depending on the signal control on the input circuit.

When the relay has to stand high currents for a long period, it is necessary to grant a proper dissipation and an adequate electrical connection between relay terminals and the load. Use the relè with an opportune heatsink (see section accessories).

Varistors, fuses, thermostats and fans are available as fittings.

#### ALARM OPTION:

for models with AC control (Input type = “A”)

#### OPERATING DESCRIPTION

The alarm output option activates closing of an isolated contact when it detects the following fault conditions:

- Control signal active but no current on load (zero current, interrupted load)
- Control signal active but no power line voltage (no line)
- Control signal active but SCR / heatsink is in overtemperature (GS thermal protection)

**NOTE:** in the absence of the control, the alarm output is always open (the alarm memory latch function is not possible, as with GS with Type “D” input).

#### ALARM OPTION:

for models with DC control (Input type “D”)

#### OPERATING DESCRIPTION.

The alarm output option activates an isolated contact (or a PNP digital output) when it detects the following fault conditions:

- Control signal active but no current on load (Zero Current, Interrupted Load)
- Control signal active but no power line voltage (no line)
- Control signal active but SCR / heatsink is in overtemperature (GS thermal protection)

The alarm output is latched: its state is maintained even when the control signal is switched off.

The alarm output resets when load current is restored or when the 24V\_supply of the GS is switched off and then on again (V\_supply reset).

The alarm output option is available in the order code as an isolated contact Solid State Switch (or as a PNP digital output) with normally open contact (or normally deactivated PNP output), or with normally closed contact (or normally active PNP digital output).

## TECHNICAL DATA

### General features

Category of use: AC1

Nominal voltage

- 230Vac (max. range 24...280Vac)
- 480Vac (max. range 24...530Vac)
- 600Vac (max range 24 ... 660Vac)

Nominal frequency: 50/60Hz

Non-repetitive voltage:

- 500Vp for model with rated voltage 230Vac
- for model with rated voltage 480Vac
- 1400Vp for models with nominal voltage of 600VAC

Switching voltage for zero: < 20V

Activation time: ≤ 1/2 cycle

Deactivation time: ≤ 1/2 cycle

Potential drop at rated current: ≤ 1.4V

Power factor = 1

### Control inputs

DC INPUT (Type "D"):

Max. input: < 10mA@32V

Max. reverse voltage: 36Vdc

AC INPUT (Type "A"):

Control voltage: 20...260VAC/VDC

Activation voltage: > 15VAC /VDC

Deactivation voltage: < 6VAC/VDC

Current draw:

<= 8 mAac/dc@260Vac/Vdc

### Alarm output option

Interruption of the load or of the line commands a contact (solid state switch or a PNP digital output (max 30V, 150mA resistance <15 ohm).

Maximum delay in tripping of load interrupt alarm < 400ms

Maximum length of wires between GS and load for correct operation of load diagnostics < 25m

## OUTPUTS

### GS 15

Nominal currents of the device with opportune heatsink in continuous work:15A

Non-repetitive overcurrent t=20 ms: 400A

I<sup>2</sup>t for blowout: ≤450A<sup>2</sup>s

dV/dt critical with output deactivated:

1000V/μs

### GS 25

Nominal currents of the device with opportune heatsink in continuous work: 25A

Non-repetitive overcurrent t=20 ms: 400A

I<sup>2</sup>t for blowout: ≤645A<sup>2</sup>s

dV/dt critical with output deactivated:

1000V/μs

### GS 40

Nominal currents of the device with opportune heatsink in continuous work: 40A

Non-repetitive overcurrent t=20 ms: 600A

I<sup>2</sup>t for blowout: ≤1010A<sup>2</sup>s

dV/dt critical with output deactivated:

1000 V/μs

### GS 50

Nominal currents of the device with opportune heatsink in continuous work: 50A

Non-repetitive overcurrent t=20 ms:1150A

I<sup>2</sup>t for blowout: ≤6600A<sup>2</sup>s

dV/dt critical with output deactivated:

1000 V/μs

### GS 60

Nominal currents of the device with opportune heatsink in continuous work: 60A

Non-repetitive overcurrent t=20 ms:1150A

I<sup>2</sup>t for blowout: ≤6600A<sup>2</sup>s

dV/dt critical with output deactivated:

1000 V/μs

### GS 75

Nominal currents of the device with opportune heatsink in continuous work: 75A

Non-repetitive overcurrent t=20 ms:1300A

I<sup>2</sup>t for blowout: ≤8000A<sup>2</sup>s

dV/dt critical with output deactivated:

1000 V/μs

### GS 90

Nominal currents of the device with opportune heatsink in continuous work: 90A

Non-repetitive overcurrent t=20 ms:1500A

I<sup>2</sup>t for blowout: ≤11200A<sup>2</sup>s

dV/dt critical with output deactivated:

1000 V/μs

### GS 120

Nominal currents of the device with opportune heatsink in continuous work: 120A

Non-repetitive overcurrent t=20 ms:1500A

I<sup>2</sup>t for blowout: ≤11200A<sup>2</sup>s

dV/dt critical with output deactivated:

1000V/μS

### Thermal protection

(only on GS models with > 40A current):

The SCR module's temperature is constantly monitored inside the device. When the maximum temperature threshold (T=110°C) is exceeded, current flow to the load is interrupted and the condition is signaled by lighting of the yellow thermal protection LED.

### Isolation

Rated isolation voltage input/output : 4000VAC rms SCR version

### Thermal features

#### GS 15

Junction temperature: ≤ 125°C

Rth junction/case: ≤ 2.0 K/W

Rth junction/ambient: ≤ 12.5 K/W

#### GS 25

Junction temperature: ≤ 125°C

Rth junction/case: ≤ 1.25 K/W

Rth junction/ambient: ≤ 12 K/W

#### GS 40

Junction temperature: ≤ 125°C

Rth junction/case: ≤ 0.65 K/W

Rth junction/ambient: ≤ 12 K/W

#### GS 50

Junction temperature: ≤ 125°C

Rth junction/case: ≤ 0.35 K/W

Rth junction/ambient: ≤ 12 K/W

#### GS 60

Junction temperature: ≤ 125°C

Rth junction/case: ≤ 0.35 K/W

Rth junction/ambient: ≤ 12 K/W

#### GS 75

Junction temperature: ≤ 125°C

Rth junction/case: ≤ 0.3 K/W

Rth junction/ambient: ≤ 12 K/W

#### GS 90

Junction temperature: ≤ 125°C

Rth junction/case: ≤ 0.3 K/W

Rth junction/ambient: ≤ 12 K/W

#### GS 120

Junction temperature: ≤ 125°C

Rth junction/case: ≤ 0.25 K/W

Rth junction/ambient: ≤ 12 K/W

### Solid State Relay Dissipated Power Calculation

Single-phase relay

Pd = 1.4 \* IRMS [W] (for GS)

IRMS = single-phase load current

## TEMPLATE DIMENSIONS

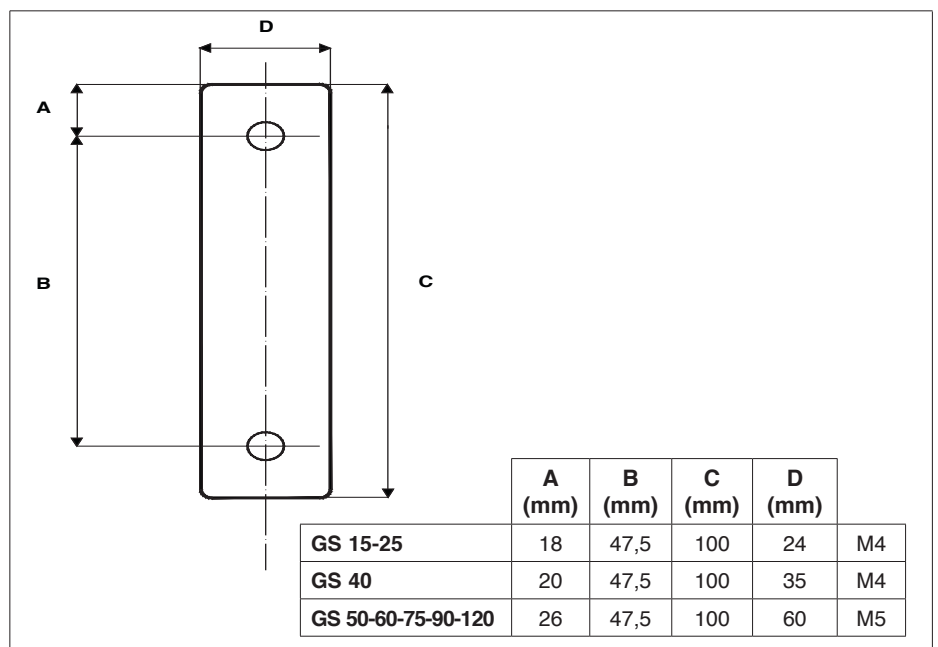

### Heatsink Thermal Resistance Calculation

$$R_{th} = (90^{\circ}\text{C} - \text{max amb. T}) / P_d$$

where  $P_d$  = dissipated power

Max. amb. T = max air temperature inside the electrical cabinet.

Use a heatsink with thermal resistance inferior to the calculated one ( $R_{th}$ ).

### Ambient conditions

- **Working temperature:** 0 to 80°C.
- **Max. relative humidity:** 50% to 40°C
- **Max. installation altitude:** 2000m asl
- **Pollution level 2**
- **Storage temperature:** -20..85°C

### Installation notes

- The heat sink must be grounded.
  - The device must be protected by an appropriate high-speed fuse (accessory).
  - Applications with solid state power units must also include an automatic safety switch to cut out the load power line.
  - Protect the solid state relay by using an appropriate heat sink (accessory).
- The heat sink must be sized according to room temperature and load current (see the technical documentation).
- Procedure for mounting on heat sink: The module-heat sink contact surface must have a maximum planarity error of 0.05mm. and maximum roughness of 0.02mm. The fastening holes on the heat sink must be threaded and countersunk.

**Attention:** spread 1 gram of thermoconductive silicone (we recommend DOW CORNING 340 HeatSink) on the dissipative metal surface of the module.

The surfaces must be clean and there must be no impurities in the thermoconductive paste.

Alternately tighten the two fastening screws until reaching a torque of 0.60 Nm for the M4 screws and 0.75 Nm for the M5 screws.

Wait 30 minutes for any excess paste to drain.

Alternately tighten the two fastening screws until reaching a torque of 1.2 Nm for the M4 screws and 1.5 Nm for the M5 screws.

We advise you to randomly check for proper installation by dismantling the module to make sure there are no air bubbles under the copper plate.

### Limits of use

- dissipation of thermal power of device with restrictions on temperature of installation site.
- requires exchange with outside air or an air conditioner to transfer dissipated power outside the panel.
- installation restrictions (distances between devices to guarantee dissipation by natural convection).
- max. voltage limits and derivative of transients in line, for which the solid state unit

has internal protection devices (depending on model).

- presence of dispersion current < 3mA for SCR version GS (max. value with rated voltage and junction temperature of 125°C).

## DIMENSIONS AND MOUNTING MEASUREMENTS

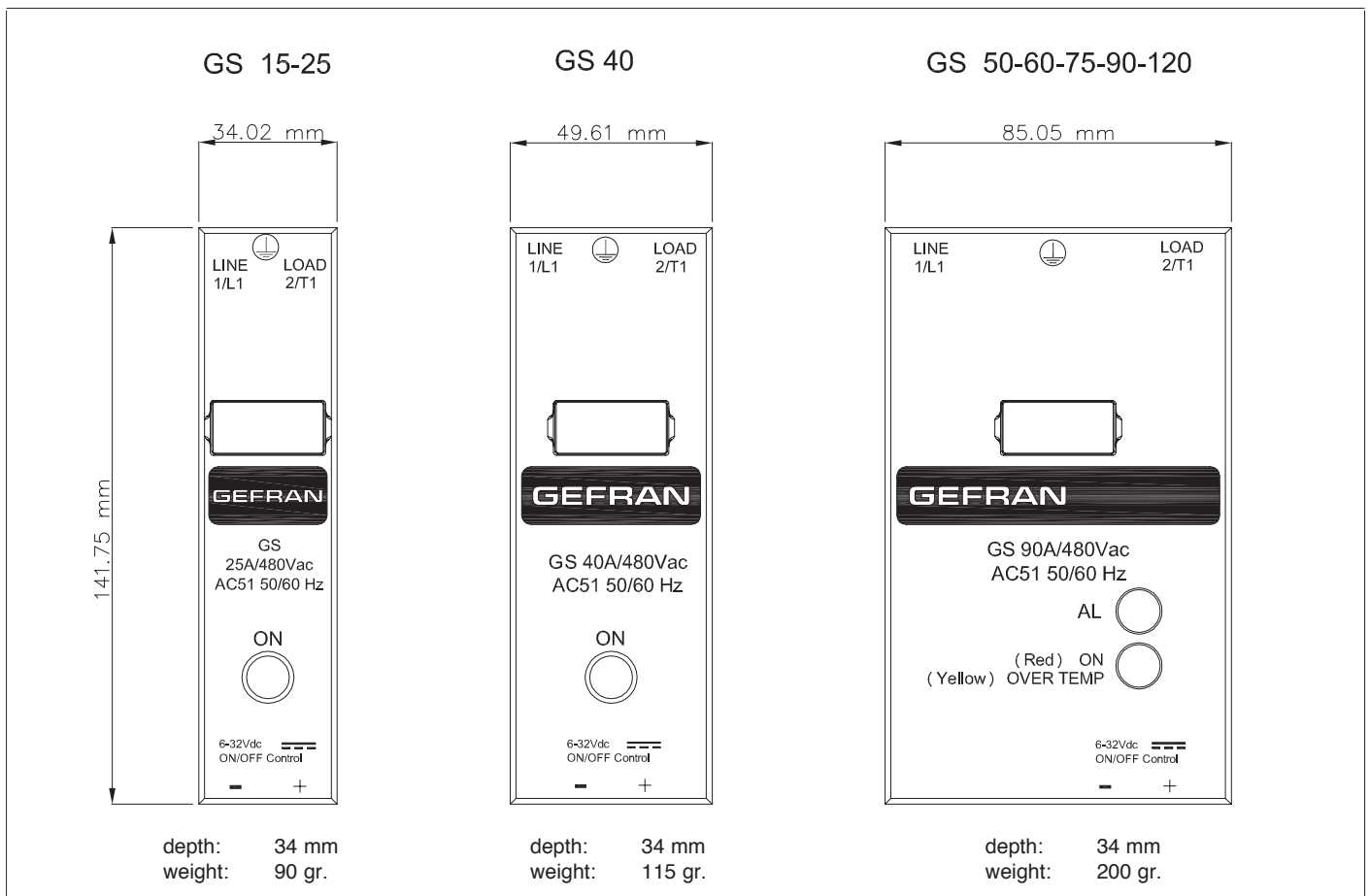

# FACEPLATE DESCRIPTION

## View of faceplate (Internal) (Models with current >40A)

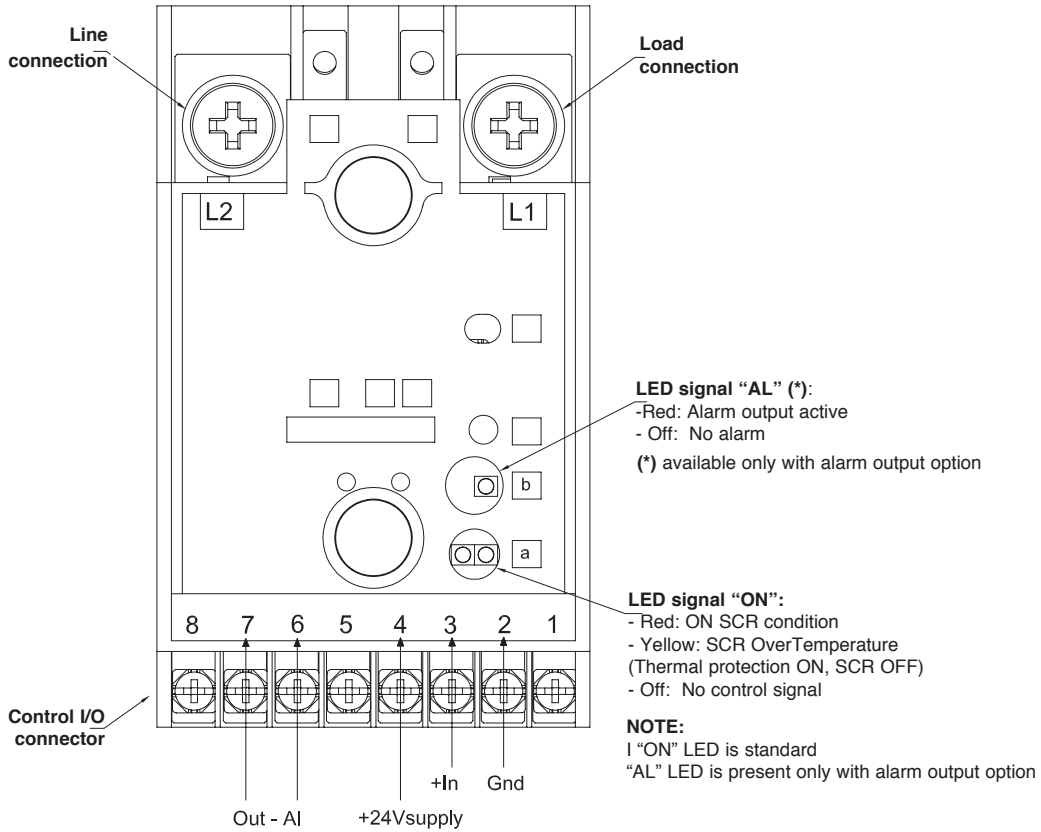

Description of I/O control terminals (GS > 40A)

Rif.	Description	Notes for type "D" input		Notes for type "A" input
1	Not used			
2	Control input GND ON/OFF	VDC input GND (Supply GND in case of option)		Vac/Vdc Inputs (Range 20 to 260Vac, I <sub>max</sub> < 8 mA)
3	+ Control input ON / OFF	Range da 6 a 32Vdc, I <sub>max</sub> = 10 mA (1 mA with alarm option)		
4 (*)	Vdc_Supply	Supply of optional functions. (Range 6 to 32 Vdc, I <sub>max</sub> < 15 mA)		Not used
5	Not used			
6 (*)	Alarm output	<b>With Options 1-2:</b> solid state contact I <sub>max</sub> = 150 mA V <sub>max</sub> = 30 Vac/dc Z <sub>closed</sub> < 15 Ω Z <sub>open</sub> > 1 MΩ	<b>With Options 3-4:</b> Terminal 6 is internally connected to terminal 4 (VDC_Supply)	<b>With Options1:</b> solid state contact I <sub>max</sub> = 150 mA V <sub>max</sub> = 30 Vac/dc Z <sub>closed</sub> < 15 Ω Z <sub>open</sub> > 1 MΩ
7 (*)	Alarm output		<b>With Options 3-4:</b> Terminal 7 is PNP digital output (+) I <sub>max</sub> = 150 mA	
8	Not used			

(\*) Optional

Control from logic output in voltage

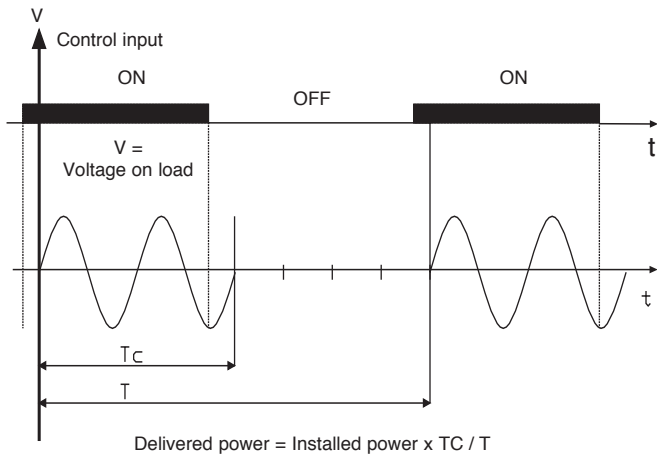

GS thermal protection  
(only for models  $\geq 50A$ )

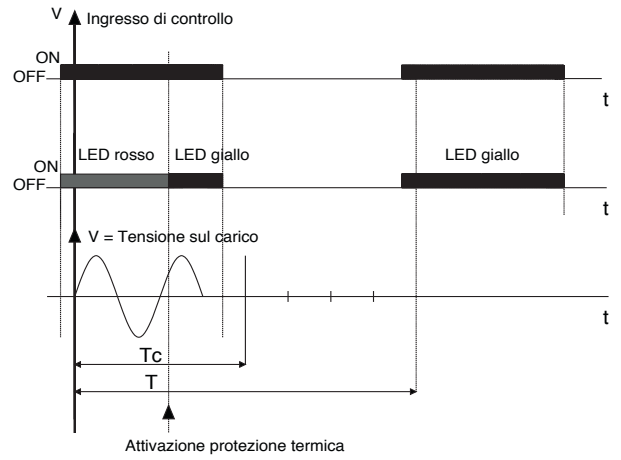

ALARM OPTION: FUNCTIONAL DIAGRAM

GS with VDC control (Control type "D")

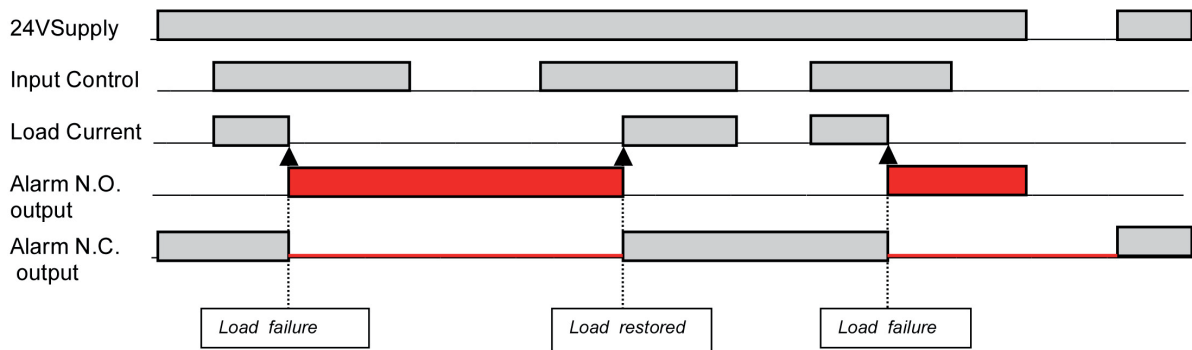

GS with VAC control (Control type "A")

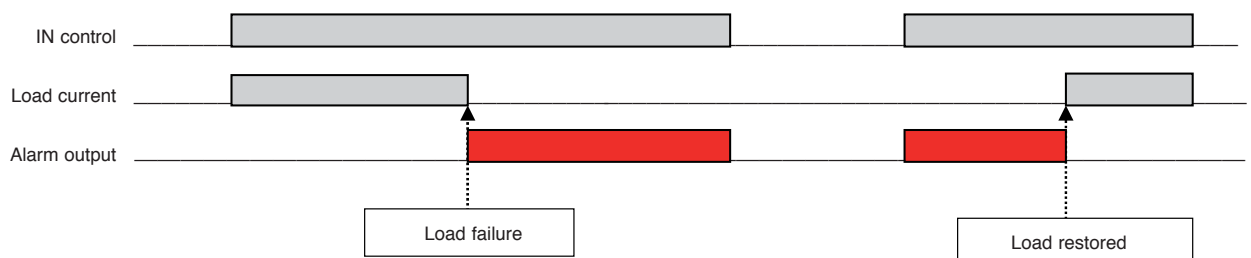

## CONNECTION EXAMPLES

### Single-phase connection

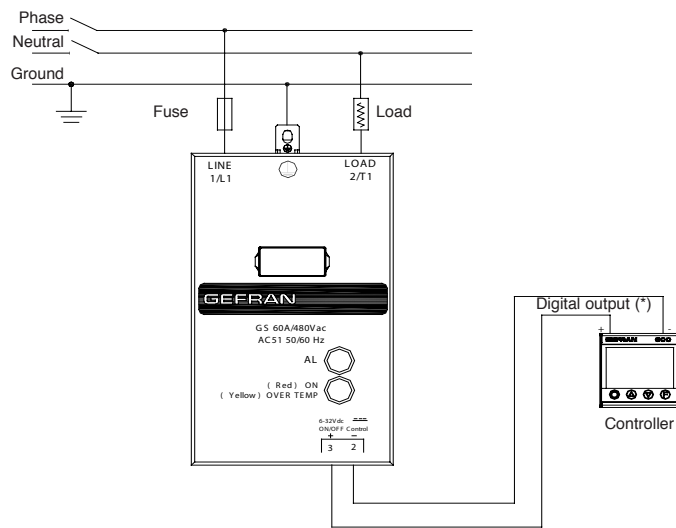

### Three-phase Star connection with neutral- GS with VDC control input (Input type "D")

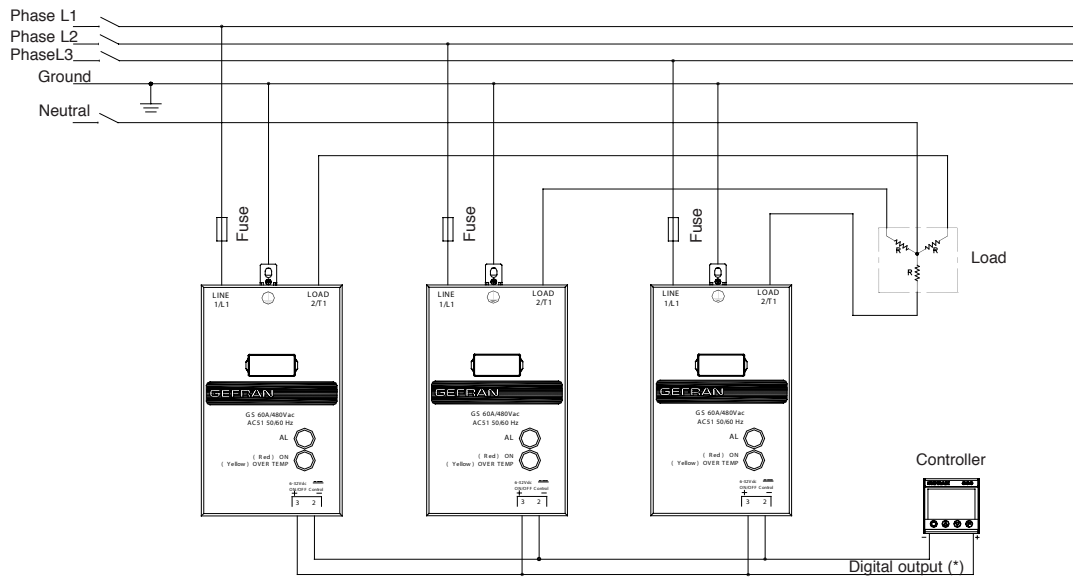

### Three-phase Triangle or Star connection without neutral on two phases - GS with VDC control input (Input type "D")

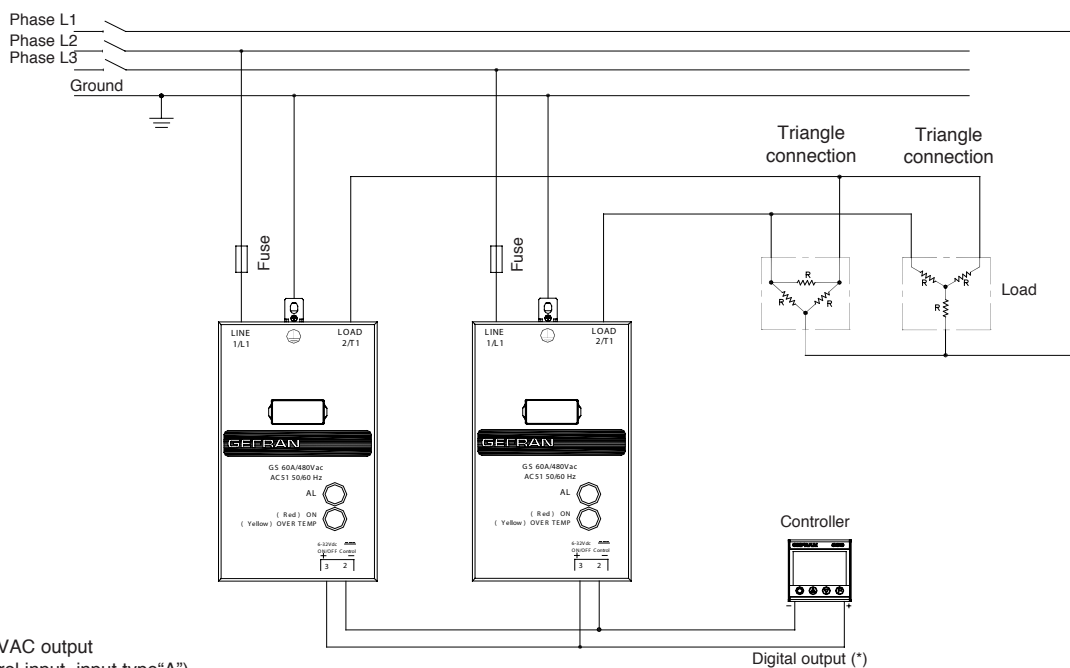

(\*) Or relay output with VAC output  
(Use GS with VAC control input, input type "A")

## CONNECTION EXAMPLES

Connection example for GS with VDC control with isolated contact alarm output option  
(only Models GS-xx/xx-D-1 or GS-xx/xx-D-2)

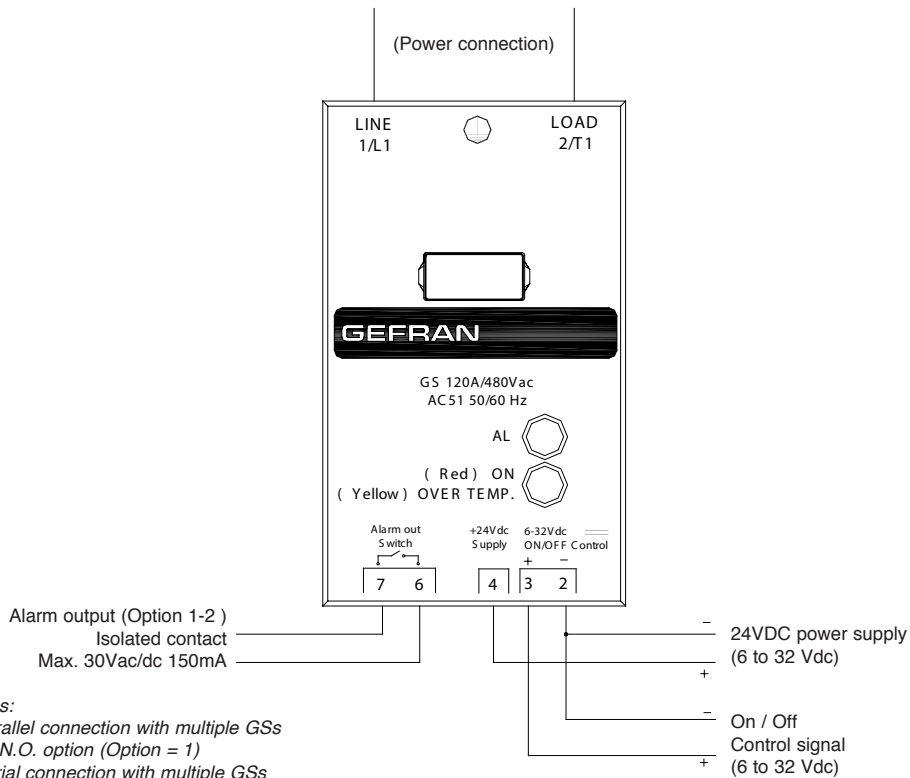

Connection example for GS with VDC control with PNP alarm output option  
(only Models GS-xx/xx-D-3 or GS-xx/xx-D-4)

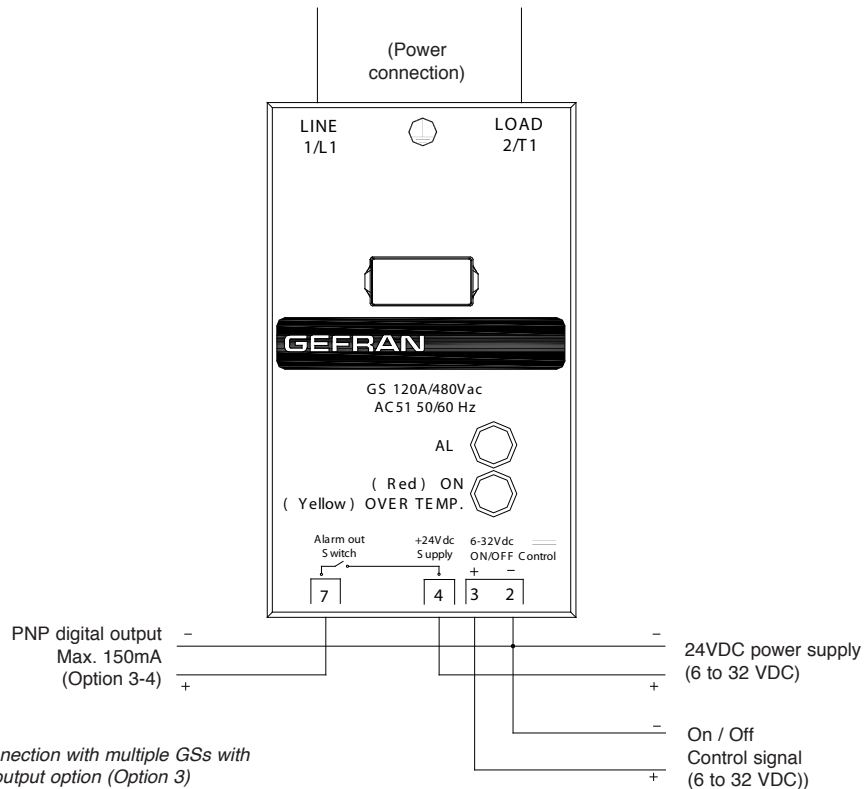

## CONNECTION EXAMPLES

Connection example for GS with VDC control with alarm output option (Option 1)  
(only Models GS-xx/xx-A-1 )

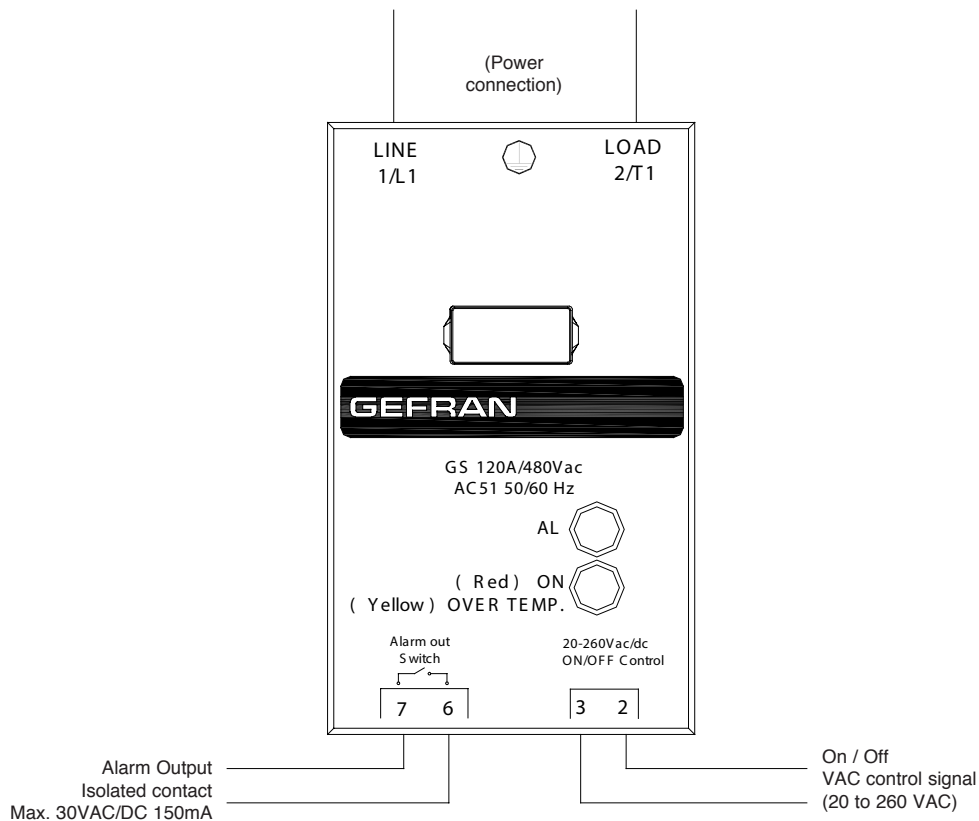

Notes:  
- Parallel connection with multiple GSs with N.O. option

## TABLE OF TERMINALS AND CONDUCTORS

Size	CONTROL TERMINAL			POWER TERMINAL			FIXING SCREWS
	Contact area (WxD) screw	Type of pre-isolated wire terminal	Max Sect.** conductor tightening torque	Contact area (WxD) screw	Type of pre-isolated wire terminal	Max Sect.** conductor tightening torque	
15A	6,4x9 M3	Eye/fork/conn. type Faston*	6mm <sup>2</sup> 0,6Nm Max	6,4x9 M3	Eye/fork/conn. type Faston*	6mm <sup>2</sup> 0,4-0,6Nm	M4 1,2 Nm
25A	6,4x9 M3	Eye/fork/conn. type Faston*	6mm <sup>2</sup> 0,6Nm Max	6,4x9 M3	Eye/fork typ	6mm <sup>2</sup> 0,4-0,6Nm	M4 1,2 Nm
40A	6,3x9 M3	Eye/fork typ	2,5mm <sup>2</sup> 0,6Nm Max	12x12 M5	Eye/fork typ	16mm <sup>2</sup> 1,5-2,2Nm	M4 1,2 Nm
50/60A	6,3x9 M3	Eye/fork typ	2,5mm <sup>2</sup> 0,6Nm Max	16x18 M6	Eye/fork typ	50mm <sup>2</sup> 3,5-6Nm	M5 1,5 Nm
75-90A	6,3x9 M3	Eye/fork typ	2,5mm <sup>2</sup> 0,6Nm Max	16x18 M6	Eye/fork typ	50mm <sup>2</sup> 3,5-6Nm	M5 1,5 Nm
120A	6,3x9 M3	Eye/fork typ	2,5mm <sup>2</sup> 0,6Nm Max	16x18 M6	Eye/fork typ	50mm <sup>2</sup> 3,5-6Nm	M5 1,5 Nm

(\*) Female faston (for insertion, remove the M3 screw by making the nut re-enter the seat in the holder)

(\*\*) The max. sections specified refer to unipolar copper wires isolated in PVC.

## ACCESSORIES

A wide range of accessories is available (including fuses and fuse holders, heat sinks, ID plates and thermostats). To choose accessories, see the section "Solid state relays - Accessories".



**ORDER CODE**

GS - [ ] / [ ] - [ ] - [ ]

Model	
Version with double SCR	<b>GS</b>

Rated current	
15Aac	<b>15</b>
25Aac	<b>25</b>
40Aac	<b>40</b>
50Aac	<b>50</b>
60Aac	<b>60</b>
75Aac	<b>75</b>
90Aac	<b>90</b>
120Aac	<b>120</b>

Rated voltage	
230Vac	<b>24</b>
480Vac	<b>48</b>
600Vac	<b>60</b>

Input type	
6 ... 32 Vdc	<b>D</b>
20 ... 260 Vac / Vdc	<b>A</b>

Alarm Output Option	
Available only for GS rated current $\geq$ 50A	
<b>0</b>	None
<b>1</b>	Insulated switch output (normally open)
<b>2 (**)</b>	Insulated switch output (normally closed)
<b>3 (**)</b>	Digital PNP output (normally open)
<b>4 (**)</b>	Digital PNP output (normally active)

(\*\*) available only for models with type "D" input

Please contact GEFran personnel for information on availability of codes.

## •WARNINGS



**WARNING:** this symbol indicates danger.

**Read the following warnings before installing, connecting or using the device:**

- follow instructions precisely when connecting the device.
- always use cables that are suitable for the voltage and current levels indicated in the technical specifications.
- in applications with risk of damage to persons, machines or materials, you **MUST** install auxiliary alarm devices.
- it is advisable to be able to check alarm states during normal operation as well
- **DO NOT** operate the device in rooms with dangerous (flammable or explosive) atmosphere.
- During continuous operation, the heat sink can reach up to 100°C, and stays at a high temperature even after the device is turned off due to thermal inertia; therefore, **DO NOT** touch it and avoid contact with electrical wires.
- do not work on the power part without first disconnecting electrical power to the panel.
- do not remove the cover when the device is powered!

**Installation:**



- correctly ground the device using the specific terminal.
- power supply lines must be separated from device input and output lines; always check that the supply voltage matches the voltage indicated on the device label.
- avoid dust, humidity, corrosive gases and heat sources.
- respect the installation distances between one device and another (to allow for dissipation of generated heat).
- to keep air in movement, we advise you to install a fan near the GST-GS group in the electrical panel containing the GST-GSs.
- respect the indicated dissipation curves

**Maintenance:** at regular intervals, check operation of the cooling fans and clean all air ventilation filters.

- repairs must be done out only by trained and specialized personnel. Cut power to the device before accessing internal parts.
- do not clean the box with solvents derived from hydrocarbons (trichloroethylene, gasoline, etc.). Using such solvents will compromise the device's mechanical reliability. Use a clean cloth moistened with ethyl alcohol or water to clean external parts in plastic.

**Service:** GEFTRAN has a service department. The warranty excludes defects caused by any use not conforming to these instructions.

GEFRAN spa reserves the right to make aesthetic or functional changes at any time and without notice.

	This device conforms to European Union Directive 2004/108/CE and 2006/95/CE as amended with reference to generic standards: <b>EN 61000-6-2</b> (immunity in industrial environment) <b>EN 61000-6-4</b> (emission in industrial environment) - <b>EN 61010-1</b> (safety regulations).
	In Conformity with <b>UL508 - File: E243386</b>

Jiangmen LEADER Electronic Co., Ltd.

#68 2nd Str, CuiShanLingShui, WuYi Country Garden, Jiangmen City, Guangdong, China

Tel:+86 750 3289680 3289698 Fax:+86 7503289699

<http://www.leadersensors.com> E-mail:leader@leadersensors.com